

# **SOUTHLAND**®

ILLUSTRATED PARTS BOOK

6 Ton Electric Log Splitter

SELS60



# Table of Contents

Unit Assembly.....	2-4
Decal Sheet.....	5

# Unit Assembly

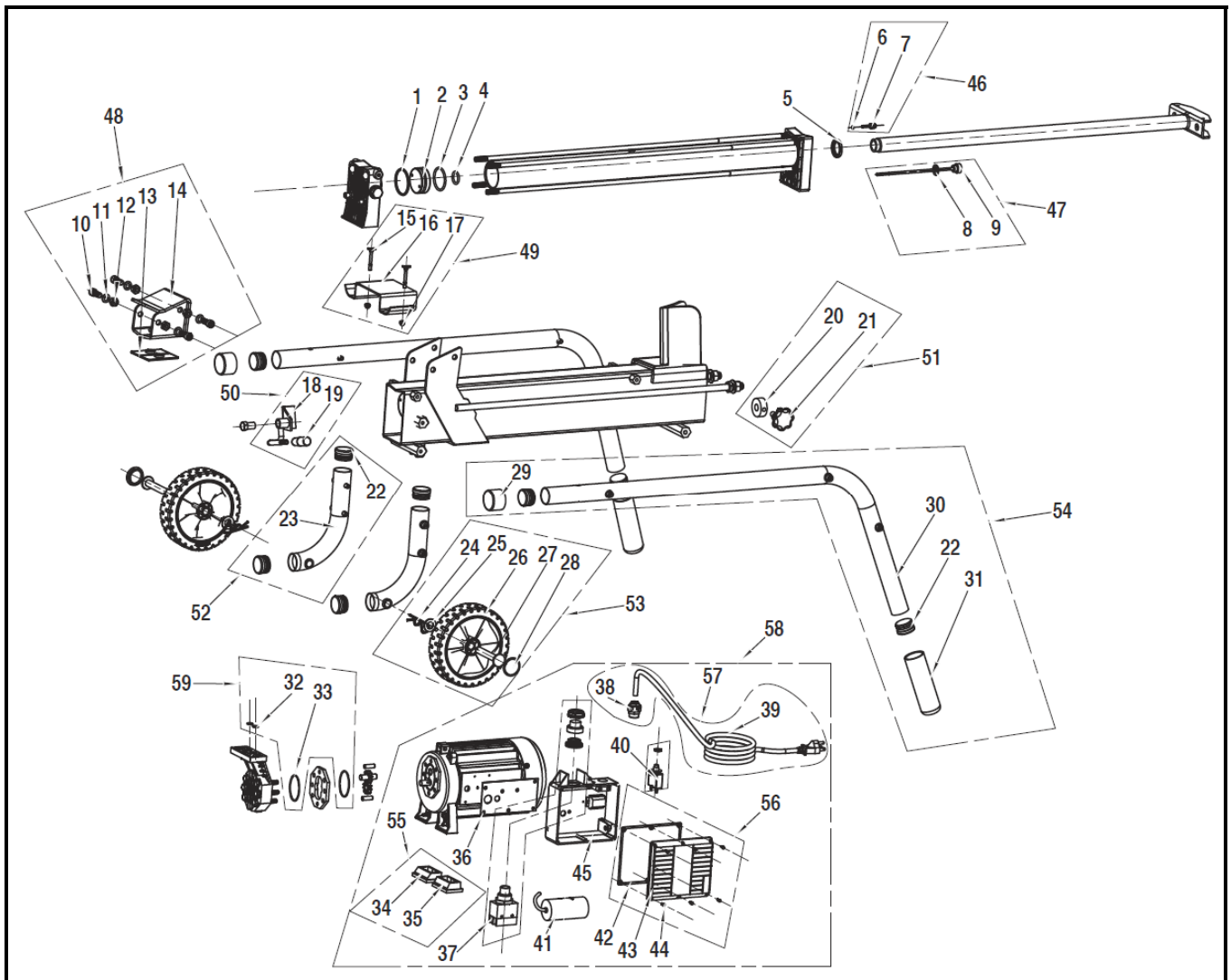

## Unit Assembly (continued)







REF. NO.	DESCRIPTION	PART NO.	QTY
1	O-Ring, 54.5 x 2.65	<i>Reference Only</i>	1
2	Piston	<i>Reference Only</i>	1
3	Ring, Piston	<i>Reference Only</i>	1
4	O-Ring, 32 x 3.5	<i>Reference Only</i>	1
5	Seal, Piston Rod	A203653	1
6	O-Ring, 7 x 1.9	<i>Reference Only</i>	1
7	Bolt, M5 x 12	<i>Reference Only</i>	1
8	Washer	<i>Reference Only</i>	1
9	Dipstick	<i>Reference Only</i>	1
10	Screw, M10 x 25	<i>Reference Only</i>	4
11	Washer, Flat M10	<i>Reference Only</i>	5
12	Nut, M10	<i>Reference Only</i>	4
13	Insert, Plastic	<i>Reference Only</i>	1
14	Ram, Log Pusher	<i>Reference Only</i>	1
15	Bolt	<i>Reference Only</i>	2
16	Bracket, Upper Tube Mounting	<i>Reference Only</i>	1
17	Nut, Cap, M6	<i>Reference Only</i>	2
18	Lever, Control	<i>Reference Only</i>	1
19	Knob, Control Lever	<i>Reference Only</i>	1
20	Block, Stroke Limiter	<i>Reference Only</i>	1
21	Knob, Stroke Limiter	<i>Reference Only</i>	1
22	Cap, Tube Rubber	<i>Reference Only</i>	8
23	Tube, Lower Rear	<i>Reference Only</i>	2
24	Clip, Clevis Pin	<i>Reference Only</i>	2
25	Washer, Flat	<i>Reference Only</i>	4
26	Wheel	<i>Reference Only</i>	2
27	Axle, Wheel	<i>Reference Only</i>	2
28	Cover, Wheel	<i>Reference Only</i>	2
29	Cap, Upper Tube Rear End	<i>Reference Only</i>	2
30	Tube, Upper	<i>Reference Only</i>	2
31	Handle Grip, Upper Tube	<i>Reference Only</i>	2
32	O-Ring, 10.6 x 2.65	<i>Reference Only</i>	2
33	O-Ring, 46.2 x 1.8	<i>Reference Only</i>	2
34	Foot, Rubber Motor, RH	<i>Reference Only</i>	1
35	Foot, Rubber Motor, LH	<i>Reference Only</i>	1
36	Underlay, Waterproof	<i>Reference Only</i>	1
37	Switch, On	A203657	1
38	Strain Relief	<i>Reference Only</i>	1
39	Power Cord with Strain Relief	<i>Reference Only</i>	1
40	Breaker, Circuit	A203660	1
41	Capacitor	A203659	1
42	Gasket	<i>Reference Only</i>	1
43	Cover, Control Box	<i>Reference Only</i>	1
44	Screw, M4 x 10	<i>Reference Only</i>	11
45	Seat, Control Box	A203662	1
46	Kit, Vent Screw with Washer (includes items #6-7)	A203652	1
47	Kit, Dipstick with Washer (includes items #8-9)	A203666	1
48	Kit, Log Pusher Ram (includes items #10-14)	A203655	1
49	Kit, Upper Tube Mounting Bracket (includes items #15-17)	A203665	1

## Unit Assembly (continued)

REF. NO.	DESCRIPTION	PART NO.	QTY
50	Kit, Control Lever with Knob (includes items #18-19)	A203656	1
51	Kit, Stroke Limiter (includes items #20-21)	A203651	1
52	Kit, Lower Rear Tube with Rubber Caps (includes items #22-23)	A203648	1
53	Kit, Wheel (includes items #24-28)	A203647	1
54	Kit, Upper Tube with Rubber Caps (includes items #22, 29-31)	A203649	2
55	Kit, Rubber Motor Feet (includes items #34-35)	A203664	1
56	Kit, Outer Box Cover with Screw and Gasket (includes items #42-44)	A203661	1
57	Kit, Power Cord with Strain Relief (includes items #38-39)	A203658	1
58	Kit, Motor with Rubber Feet (includes items #34-45)	A203663	1
59	Kit, O-Ring Pump (includes items #32-33)	A203654	1

# Decal Sheet

**⚠ WARNING**

	<b>READ AND FOLLOW OPERATING INSTRUCTIONS BEFORE USING LOG SPLITTER.</b>		<b>ELECTRIC SHOCK HAZARD</b>
	<b>IMPACT OR PINCH HAZARD</b> - Keep bystanders at least 10 feet away.		- Disconnect from power before servicing.
	- Only one person should operate and load the log splitter, staying within the designated operating zone.		- Do not use in wet or damp conditions.

To Split Wood: Depress motor switch and move control lever downward. Release for return.

**⚠ WARNING**

**CRUSH HAZARD**

To avoid injury:  
Keep arms and hands away from moving parts.





**NOTICE**

- Before use, loosen vent screw three turns.
- After use and before moving, retighten vent screw to avoid leakage.



REF. NO.	DESCRIPTION	PART NO.	QTY
	Decal Sheet	A203667	1